



OPERATING INSTRUCTIONS

for the vinyl cutters

**Secabo C30IV, C60IV, C120IV
S60, S120, S160**

Congratulations on purchasing a Secabo product!

Please read these operating instructions carefully before using the product.

Any reproduction of these operating instructions in any form requires the written approval of Secabo GmbH. We reserve the right to amend technical data and product characteristics without prior notice.

Secabo GmbH assumes no liability for direct or indirect damage or injury resulting from the use of this product.

Version 2.0 (04.07.2014)







Safety Precautions

Please read these instructions and safety precautions carefully before using your Secabo product for the first time!

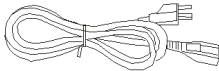
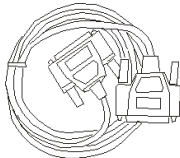
- Do not place any magnetic objects in the vicinity of the cutting head; otherwise uniform contact pressure is not ensured.
- Do not remove the connection cable to the computer while plotting is in progress.
- Relieve the pressure on the pressure rollers when not in use by moving the pressure lever up.
- Do not reach into the unit with your hands when the power is connected.
- Never open the housing or attempt to modify the unit yourself.
- In case you are requested by the Secabo customer support to open the heating plate cover, please make sure you are wearing respiratory protection and only touch the contained insulation wool with gloves. Any disposal of the wool must be contained in a closed bag.
- Ensure that liquids and metal objects do not get into the inside of the plotter.
- Ensure that the wall socket used is grounded and protected with a ground fault switch.
- Ensure that the connected voltage (220V) does not deviate by more than $\pm 10\%$. Otherwise install a voltage stabilizer.
- Disconnect the power cord when the unit is not used for a longer period of time.
- Never reach into the unit in the vicinity of the blade holder during the cutting operation!
- Discontinue any printing jobs in progress before readjusting the blade holder!
- Always ensure that the vinyl cutter is out of reach of children during operation and never leave the unit or individual parts of it switched on without supervision.
- Do not touch the tip of the sliding blade to avoid injury.
- Always place the unit on a stable base to prevent it from falling down.
- Do not operate the unit during thunderstorms; it can be damaged or destroyed by lightning.

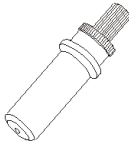
Items Included

Before starting work, please check whether the following items are all present:

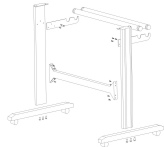
Item	Quantity	
Vinyl cutter	1	
Power cable	1	
Serial connection cable	1	
USB connection cable	1	
Bladeholder	1	
Penholder	1	
30° drag knife	1	
Pen	1	
DrawCut license	1	
Stand (60 and 120 models only, not BASIC)	1	

Layout of Stand-Up-Base

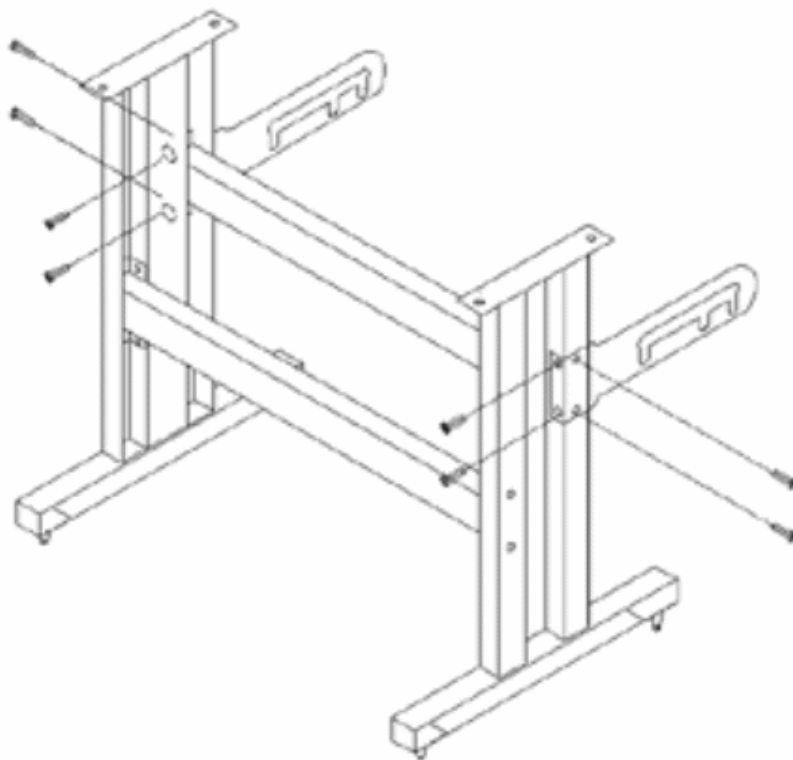

The stand-up base for your Secabo vinyl cutter can be assembled rather simply by using the parts supplied, -as shown in the exploded drawing above.

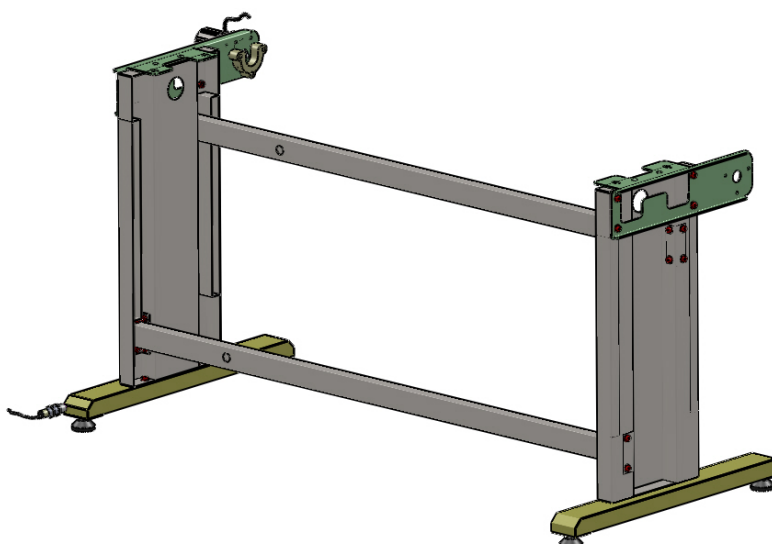

The drawing above shows the assembly of the S160 stand.

Unit parts and their function

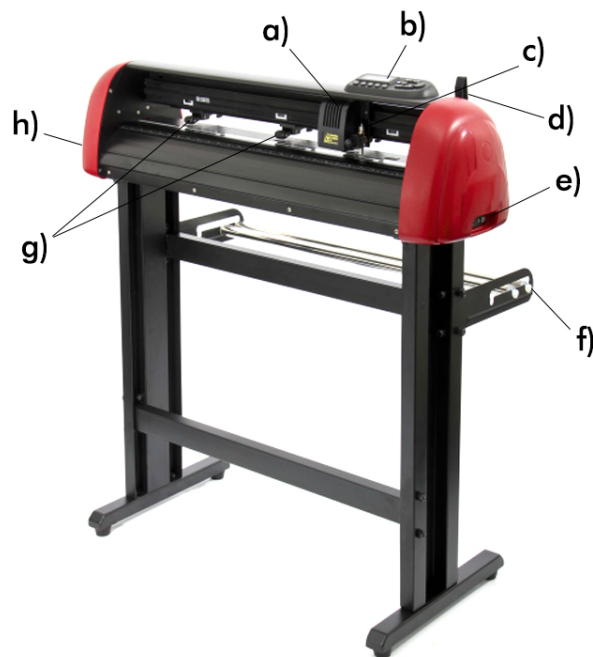

- a) Cutting head with LAPOS Laser
- b) Control panel
- c) Knifeholder
- d) Pressure lever for all grid rolls
- e) USB- and serial interface
- f) Rollholder
- g) Grid rolls
- h) Power supply, fuse, switch (no picture)

Control Panel



Starting-up Appliance and Software

Attention! For a smooth operation and complete configuration firstly install DrawCut LITE or PRO.

Installation DrawCut LITE

Your Secabo vinyl cutter includes the software DrawCut LITE. This software has to be activated online. It is not necessary to have internet access on the computer you are using DrawCut LITE with - the activation on other devices is also possible.

To control your vinyl cutter by your computer install the software as described:

- For the time of installation de-activate your Windows-firewall and all used anti-virus-software.
- Download the current version of DrawCut LITE under <http://www.draw-cut.com/#downloads> and follow the assistant's instructions.
- Your 26-digit DrawCut serial number can be found on supplied printed sheet. When requested, please enter the code.
- Now DrawCut LITE can be used.

Installation of your Secabo vinyl cutter in DrawCut

Be aware that your vinyl cutter only can be used with Windows XP, Windows Vista, Windows 7 and Windows 8.

- Connect your computer with the internet..
- Connect your vinyl cutter to your computer by using provided USB-cable.
- Switch on your device.
- Your vinyl cutter will be detected. Windows is searching for the right drivers and installing them automatically. This can take some time.
- The device is ready for operation.
- Start DrawCut.
- Open the "Vinyl Spooler" in DrawCut.

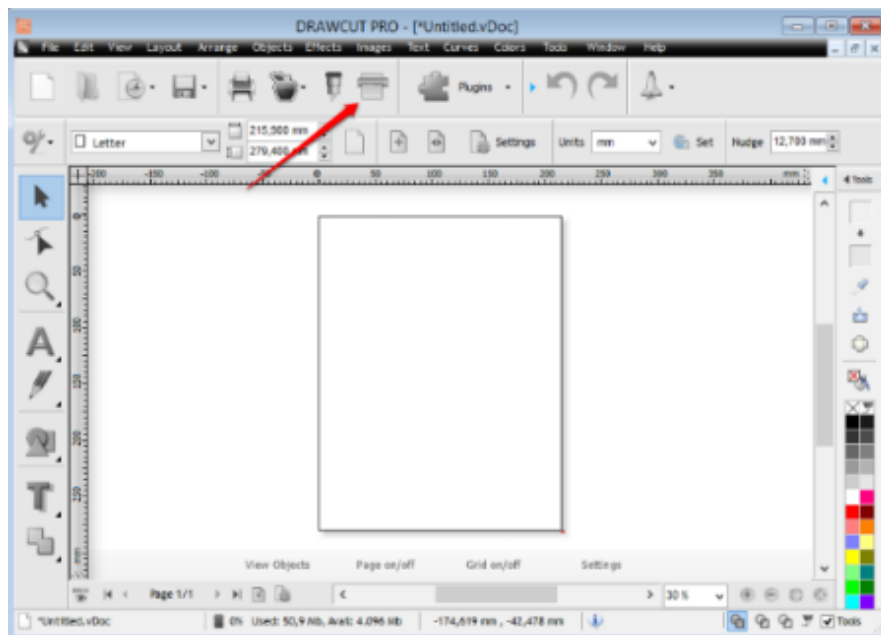

- Click on the tab “connection”

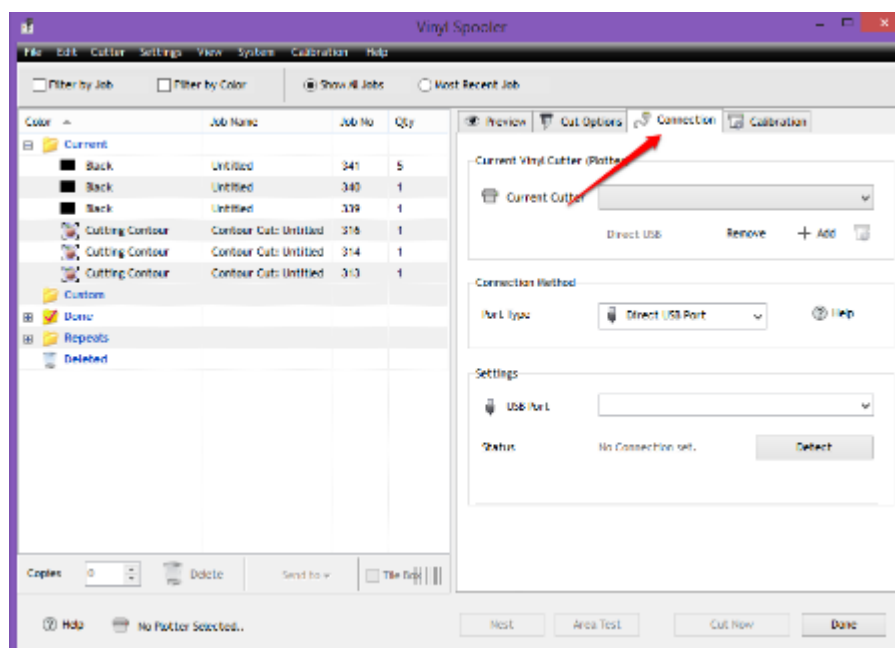

- Add your vinyl cutter by clicking the “Add”- button (the example shows a Secabo S60), choose your model and click on “Install”.

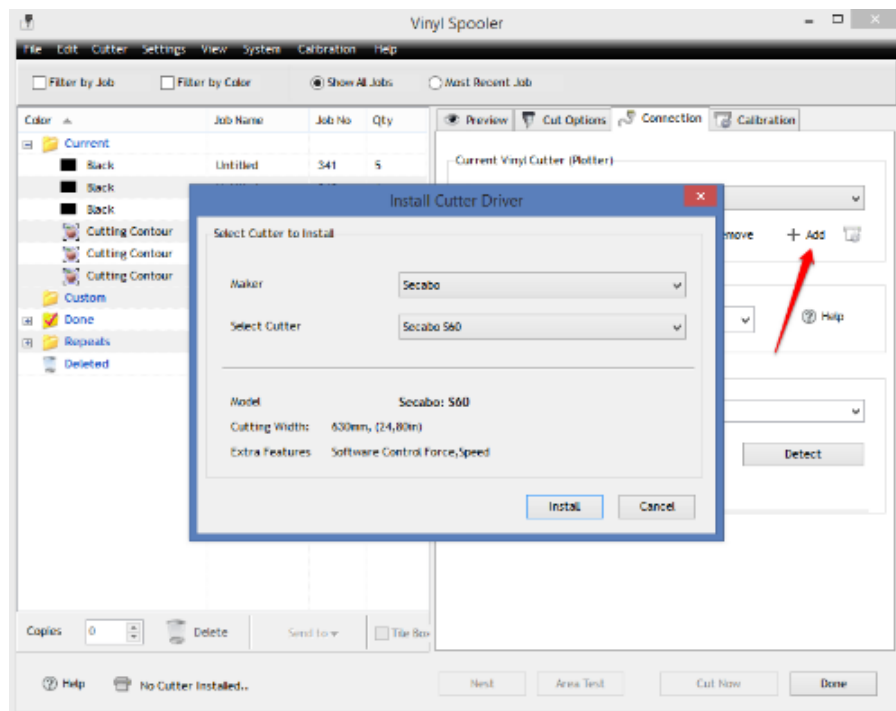

- Click on the “Detect”-button and follow the instructions of the installation assistant. Just press on. Confirm the message with clicking on the “Done”-button. Now you can control your Secabo vinyl cutter directly from DrawCut.

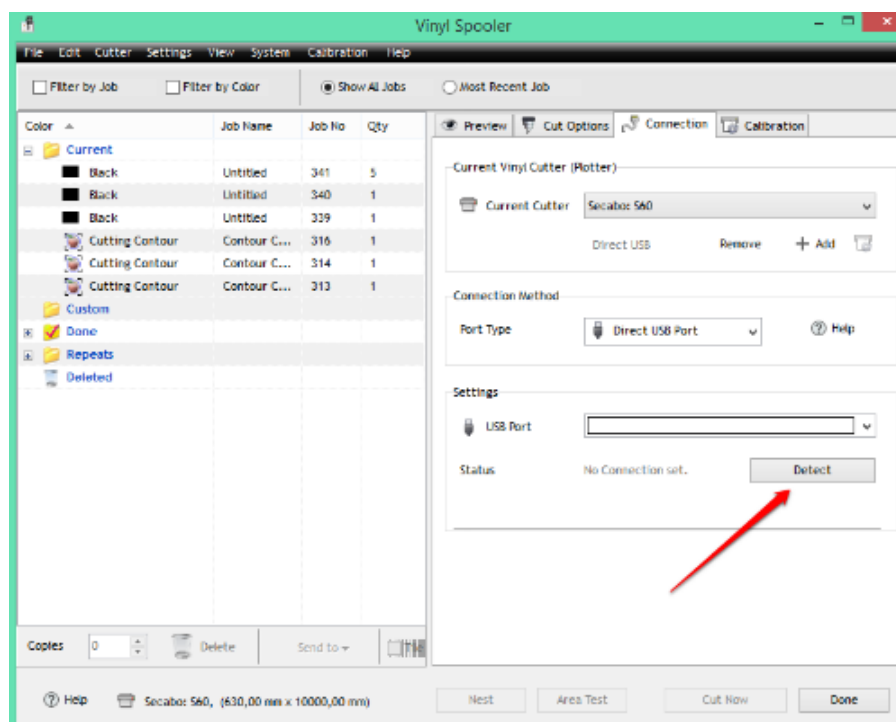

Starting Up Appliance

Ensure that there is sufficient space for the vinyl transport at the front and at the back of the unit. The vinyl cutter should be operated only in clean and dry surroundings.

- Connect the plotter to a 220 V wall socket with the power cable provided.

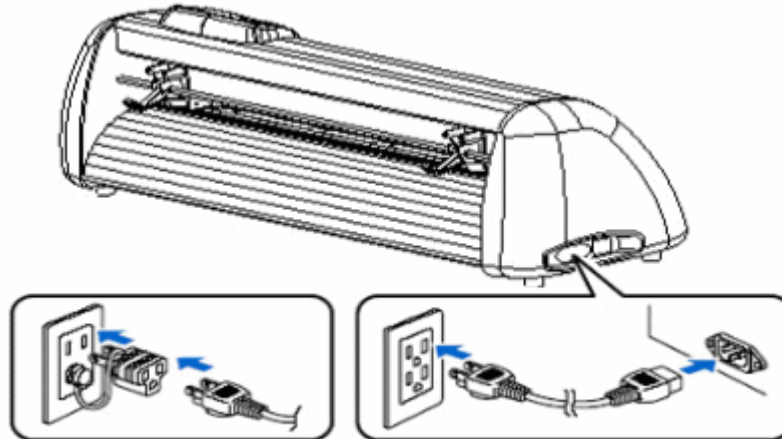

- Then switch the plotter on.

Installing and adjusting the blade

- Take one of the cutting blades supplied and place it in the blade holder so that the sharp side extends at the front. The blade is held by a magnet in the blade holder.
- Adjust the cutting depths by turning the front cap.
- The depth is initially set correctly when you can carefully move your fingertip across the blade and feel only a light scratching. Since the depth adjustment for the blade depends on the material, it may be necessary to change it later.
- Secure the blade by closing the gold lock nut.
- Press the pin on the rear of the blade holder to remove and replace the blade at any time.
Caution – Injury hazard!

The various material thicknesses require different blade settings or even special blades; it may therefore be necessary to repeat the adjustment described above.

Inserting the Knifeholder

- First turn the clamping screw for the blade holder on the cutting head until it is open wide enough.
- Press down the blade holder from above and until contact with the hole on the right side and pull the lock nut tight. Please ensure that the blade holder is secured correctly.



- a) Bladeholder
- b) Clamp

Inserting the material

- Always insert the material to be printed into the unit from the rear.
- Pull the vinyl up to the cutting bar in order to correctly set the zero point. Details on setting the zero point are given under Point 6.3 in these instructions.
- If you use a roll of vinyl instead of vinyl sheets, the vinyl can be rolled off cleanly with the aid of the roll holder supplied.
- When inserting the material, please ensure that the foil is inserted straight so that tearing of the foil is prevented during transport. The scaling guides at the front and back will help to ensure this. If the foil is inserted only millimetres short of straight this could result in serious alignment problems later on.

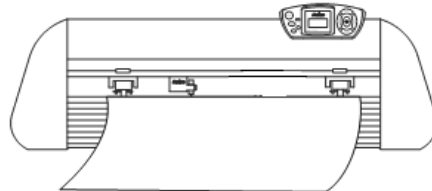

- You can slide the foil to any position in the unit, provided that the pressure rollers are within the white/black squares on the crossbar.
- Lock the two pressure rollers by turning down the cocking lever on the outer edges of the foil (about 2cm indented), so that the film is transported and a maximum cutting area is guaranteed.
- The pressure rollers can be moved by tensioning the spring on the respective desired position.

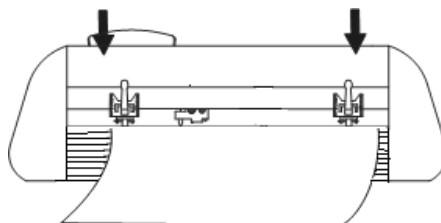

Cutting Test



- Confirm the cutting tests in „Online Mode“ by clicking the „Test“ button. The vinyl cutter will cut a triangle with a rectangular border in the inserted foil/vinyl at the saved zero point.
- You can check the adjustment of the blade holder as well as the contact pressure with this cutting test. The material inserted should be cut cleanly and straight during the cutting test; the backing material should not be damaged.
- If the backing material has been cut through, either the contact pressure is set too high or the blade or blade holder is adjusted incorrectly. Change these adjustments and perform the cutting test again.
- Also readjust if the vinyl was cut imprecisely or to an insufficient depth.

The first plotting job

- Start the cutting software DrawCut LITE.
- Create a lettering or a graphic with the help of the text tool and click on the knife holder symbol in the menu bar
- The menu “send to vinyl cutter” appears, click on the “Cut”-button on the right bottom
- “Vinyl spooler” is opening with a preview of the plot on the right side. Click the “Cut”-button and confirm the query with “Yes”
- The cutting procedure begins!

Settings and Operation

Online/Offline



After switching on the unit a reset is performed and the unit switches to the online mode. By selecting the on/off line button on the panel, you can switch between online and offline mode.. During the cutting operation, the vinyl cutter must generally be in the online mode, to change the configuration settings, the unit must be offline.

Moving the Cutting Head



The blade can be moved left and right by pressing the „Force“ arrow in offline mode as well as forwards or backwards by pressing the „Speed“ arrow. . The corresponding X and Y coordinates are shown on the display.

Setting the Zero Point



In order to set the correct output point on the plotter, move the blade holder and foil, in offline mode, so that the blade is in the right corner of the foil. Confirm the zero point by pressing the crosshairs, thereby ensuring the device automatically changes in online mode.

Change Speed and pressure

You can make the following changes in the online mode by pressing the corresponding buttons:

Increase speed	Reduce speed	Increase pressure	Reduce pressure

The cutting speed and contact pressure cannot be changed while a plotting job is in progress.

Other Settings



In online mode the Set-button can page through further configuration menus.

- The baud rate can be set, this is however only necessary if you wish to control the device in serial mode.
- In the second menu point, one can calibrate the cutting plotter correctly. Correction may be required here due to wear to the mechanical parts. The X and Y scaling of the data can be changed by changing the Xp and Yp values. If, for example, an object entered with a length of 100 cm on the computer is cut on the vinyl cutter to a length of only 98cm, it is necessary to correct the corresponding scaling value on the plotter. Otherwise, these values should not be changed.

Reset button

With the help of the reset button, you can cancel processes. This can be helpful when, for example, a job was obviously generated too large.



Contour cut with LAPOS

LAPOS is a system for positioning of pre-printed media in your C60IV/S60 vinyl cutter, to cut the printed elements precisely, perfectly aligned and without offset. The use of LAPOS is shown in the following steps.

Calibration

Before using LAPOS for the first time the cutter has to be calibrated to determine the correct Laser-offset. DrawCut offers two procedures, one quick and one detailed version.

- Please open the “Vinyl Spooler”.

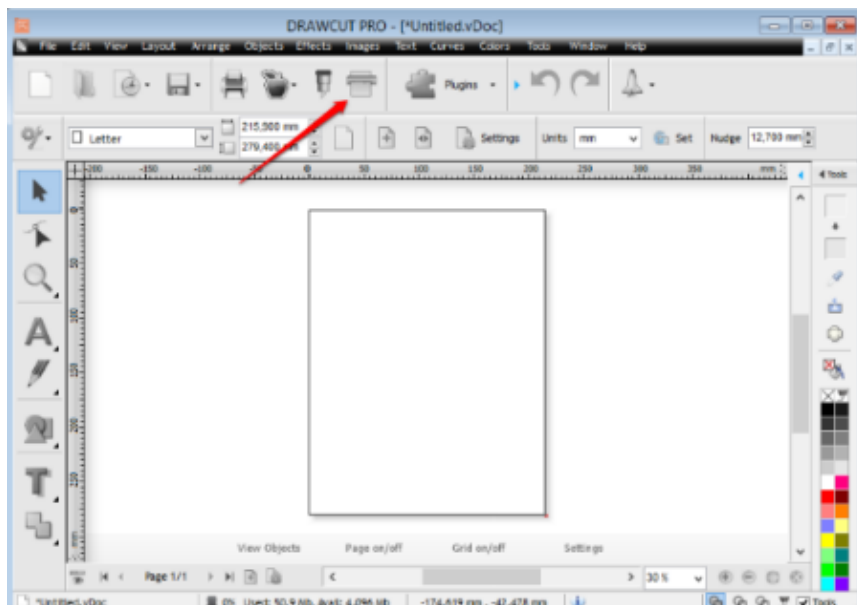

- Click on the tab “Calibration”. Choose the quick or the detailed version and follow the instructions of the respective assistant..

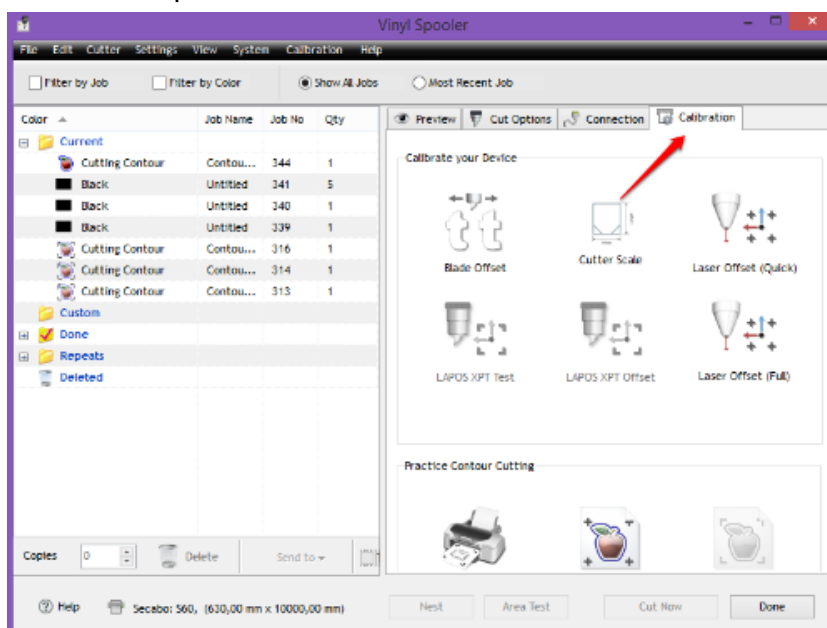

After completing the calibration you can start with the actual contour-cut.

- Firstly create a lettering with the text tool or import any vector graphic.
- Open the contour-cut assistant in the header.

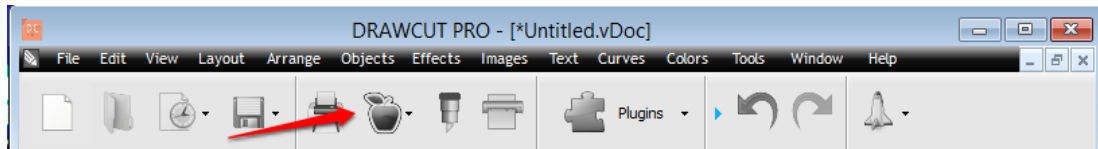

- Use the “Create cut-contour” and create a contour with your personal parameters. Press “OK”.

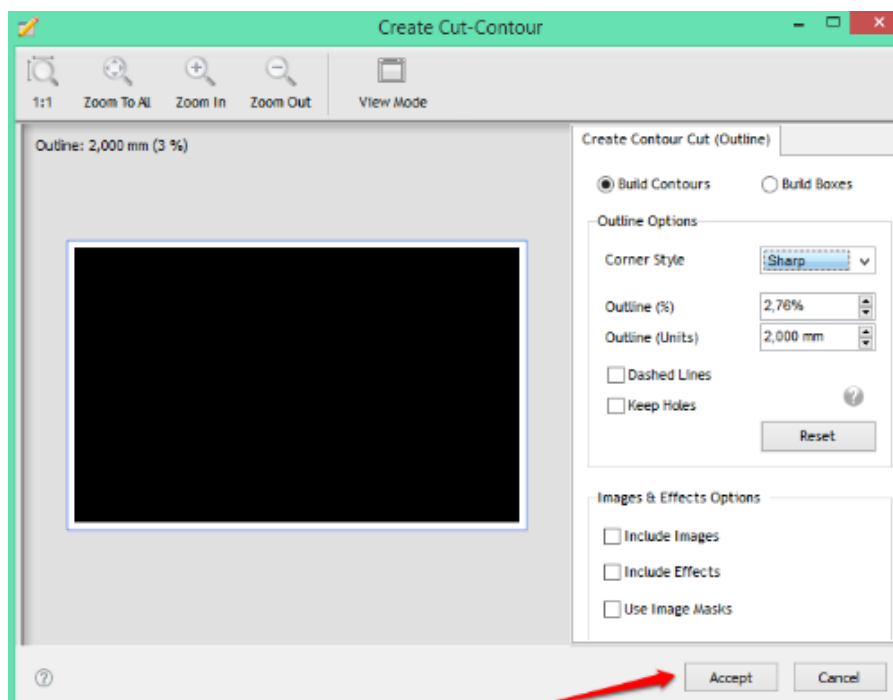

- Open the contour-cut assistant.
- Print the designed graphic with the crop marks. Take care that the printed sheet has the actual size.

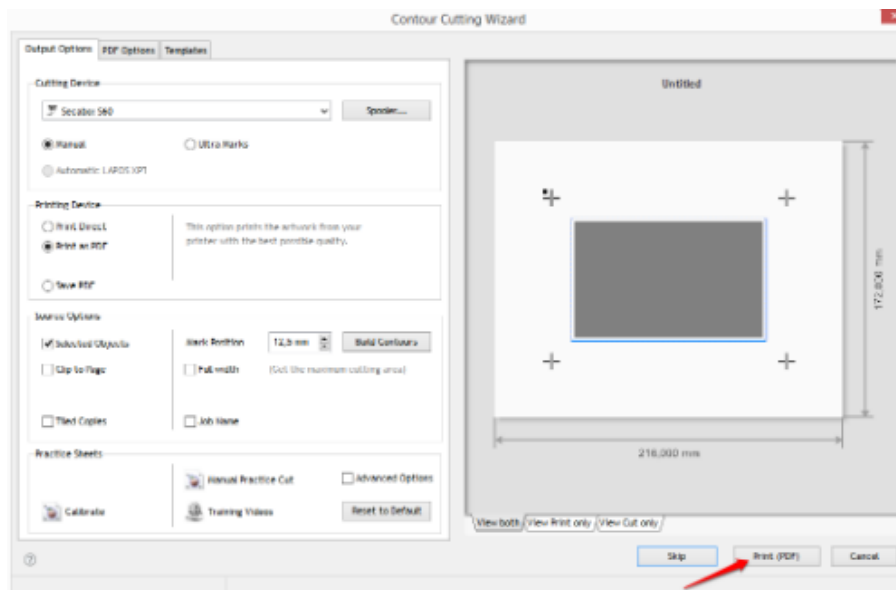

- After printing press the “Cut”-button.

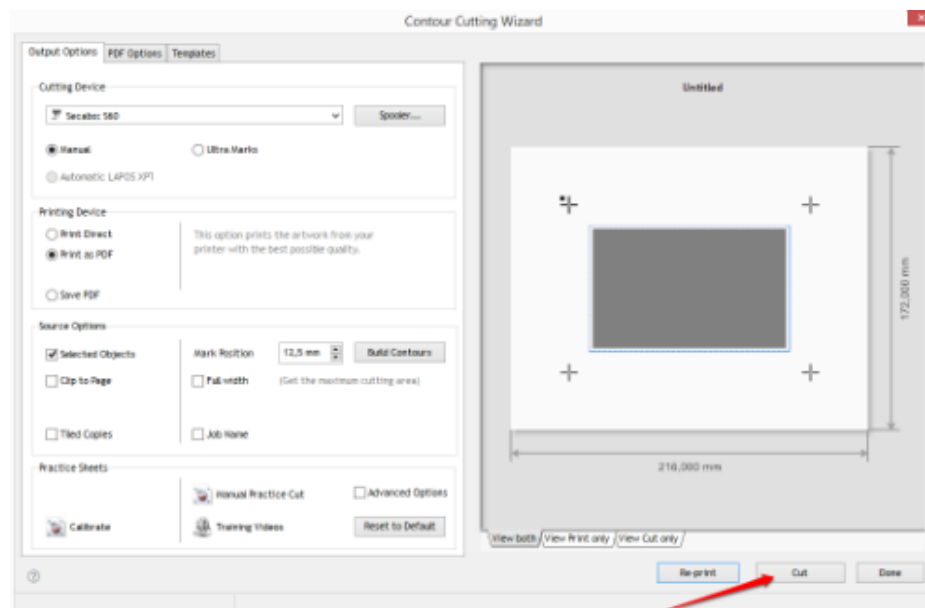

- The Align Cutfile assistant opens itself.
- Choose the Alignment Method with 4 points, to achieve the greatest possible precision.
- Insert the print as shown in the picture into the vinyl cutter.
- Click on the “Next”-button and follow the instructions of the Align Cutfile assistant to start the contour-cut.

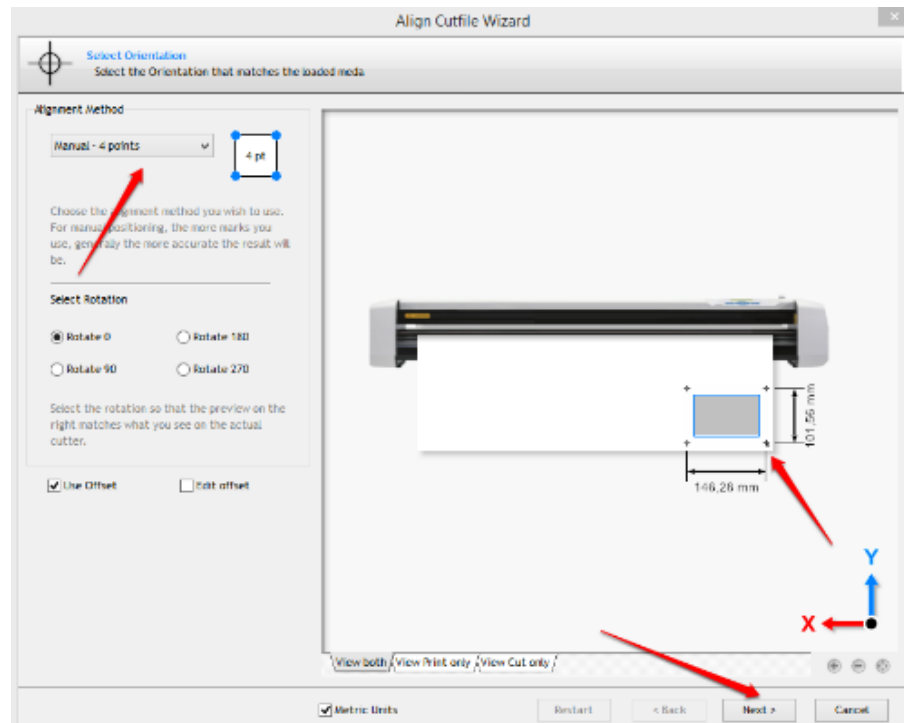

Drag knives

Drag knives are sensitive, sharp and dangerous precision tools.

- Always keep the blades away from children!
- Exercise care when handling blades to prevent injuries.

Treat the cutting blades carefully and always store them with the associated protective cap when not in use. If the tip of a blade hits against a hard material such as glass or stone, tiny chips can be broken out of the tip rendering the blade unusable.

Please observe the following notes to prevent unnecessary wear to your blades and achieve the maximum possible service life.

- Always avoid cutting into the backing material on the vinyl. The wear to the blades is increased when it is necessary for them to cut deeper into the material used.
- Adjust the cutting depth of the blade so that the material is just cut through cleanly. Further extension of the blade reduces its service life and does not improve the cutting results at all
- Use specially designed blades for thicker material (e.g. flock blades for flock).
- Ragged edges after cutting the vinyl indicate that the blade is dull. Always replace dull blades immediately!

Technical Data

Model	C30IV
Type	Vinyl cutter with stepper motor
Max. media width	420mm
Max. cutting width	330mm
Interfaces	RS232C, USB
Display	backlit, grafic LCD display
Memory	4MB
Max. cutting speed	600mm/s
Max. media thickness	1mm
Downforce	50g-500g
Mechanical resolution	0,0245mm
Repetition accuracy	< +/- 0,1mm
Power supply	AC 90V - 240V / 50Hz - 60Hz
Environment	+5°C - +35°C / 30% - 70% humidity
Weight without packaging	9kg
Weight with packaging	12kg
Dimensions (W x H x D)	660 x 260 x 260mm

Model	C60IV	S60
Type	Vinyl cutter with stepper motor	Vinyl cutter with servo motor
Max. media width	720mm	720mm
Max. cutting width	630mm	630mm
Interfaces	RS232C, USB	RS232C, USB
Display	backlit, grafic LCD display	backlit, grafic LCD display
Memory	4MB	4MB
Max. cutting speed	600mm/s	960mm/s
Max. media thickness	1mm	1mm
Downforce	50g-500g	50g-750g
Mechanical resolution	0,0245mm	0,01254mm
Repetition accuracy	< +/- 0,1mm	< +/-0,01mm
Power supply	AC 90V - 240V / 50Hz - 60Hz	AC 90V - 240V / 50Hz - 60Hz
Environment	+5°C - +35°C / 30% - 70% humidity	+5°C - +35°C / 30% - 70% humidity
Weight without packaging	15kg	15kg
Weight with packaging	25kg	25kg
Dimensions (W x H x D)	920 x 260 x 260mm	920 x 260 x 260mm

Model	C120IV	S120
Type	Vinyl cutter with stepper motor	Vinyl cutter with servo motor
Max. media width	1350mm	1350mm
Max. cutting width	1260mm	1260mm
Interfaces	RS232C, USB	RS232C, USB
Display	backlit, grafic LCD display	backlit, grafic LCD display
Memory	4MB	4MB
Max. cutting speed	600mm/s	960mm/s
Max. media thickness	1mm	1mm
Downforce	50g-500g	50g-750g
Mechanical resolution	0,0245mm	0,01254mm
Repetition accuracy	< +/- 0,1mm	< +/-0,01mm
Power supply	AC 90V - 240V / 50Hz - 60Hz	AC 90V - 240V / 50Hz - 60Hz
Environment	+5°C - +35°C / 30% - 70% humidity	+5°C - +35°C / 30% - 70% humidity
Weight without packaging	30kg	30kg
Weight with packaging	41kg	41kg
Dimensions (W x H x D)	1600 x 260 x 260mm	1600 x 260 x 260mm

Troubleshooting

Jobs are always output too large.

Possible causes:

- Resolution incorrectly adjusted (increments in mm).
- Output size greater than 100%.

An imported job (EPS) is plotted a number of times at the same position.

Possible causes:

- File may be corrupted and should be checked.

Straight lines are cut zigzag.

Possible causes:

- Blade adjustment and/or contact pressure incorrect and should be checked.

Konformitätserklärung

Statement of Conformity



Hiermit erklären wir in alleiniger Verantwortung, dass das unter „Technische Daten“ genannte Produkt mit den Bestimmungen der folgenden EG-Richtlinien und Normen übereinstimmt:

We herewith declare under sole responsibility that the under „technical data“ mentioned product meet the provisions of the following EC Directives and Harmonized Standards:

EG-Richtlinien / EC Directives:

2006/95/EG Niederspannungsrichtlinie

2006/95/EC Low Voltage Directive

98/37/EG Maschinenrichtlinie (2006/42/EG ab 29.12.2009)

98/37/EC Directive on machinery (from 2009-12-29: 2006/42/EC)

Norm / Standard:

EN 60204-1:2006

Technische Dokumente bei / Technical documents at:

Secabo GmbH, Hochstatt 6-8, 85283 Wolnzach, Germany

Dipl. Ing. Fabian Franke

Dipl. Ing.(FH) Bernhard Schmidt